

## Guide to placement of the concentrator and antennas

The bars indicate how much your placement of the concentrator antenna affects the meter coverage.

The concentrator antenna can be placed either indoor or mounted outdoor. However, optimum coverage is achieved when the antenna is placed outdoor.

If your antenna must be placed indoor then choose a placement with unobstructed access to most floors e.g. a stairway.

Should you need further guidance, please contact your local sales representative.



150 apartments. Current building + 2 nearby buildings



100 apartments. Current building + 1 nearby building



50 apartments. Current building



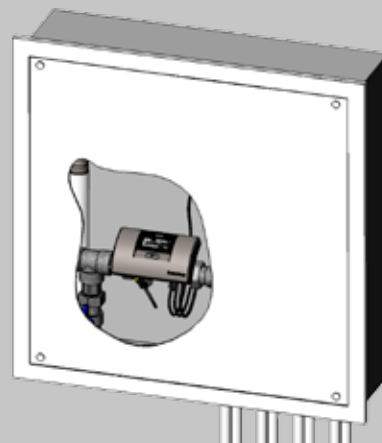





If the installed meters are placed in a steel box, the number of apartments covered is reduced.

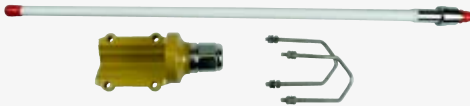

The coverage mentioned above should be considered a guideline. Actual coverage may vary from this.

# Choose the right antenna solution

Based on the placement chosen, the table below helps you choose your right antenna solution. The concentrator works with just a single antenna, however, it is recommended to use two antennas for optimum coverage. For single antenna operation choose an antenna from the primary antenna column below.

| Antenna placement                                                                   | Primary antenna                                                                                              | Secondary antenna                                                                                              |
|-------------------------------------------------------------------------------------|--------------------------------------------------------------------------------------------------------------|----------------------------------------------------------------------------------------------------------------|
|    | Omni antenna outdoor<br>    | Panel antenna outdoor<br>  |
|  | Panel antenna outdoor<br> | Panel antenna outdoor<br> |
|  | Omni antenna outdoor<br>  | Panel antenna indoor<br>  |

58113240\_A1\_GB\_08.2015