

Installation guide

Pulse Transmitter/Pulse Divider



Contents

1	Installation	3
1.1	Orientation of Pulse Transmitter/Pulse Divider	3
1.2	Installation examples	4
2	Electrical connection	5
2.1	Signal cable length	5
2.2	Connection for ULTRAFLOW® and MULTICAL®	6
2.3	Pulse output in Pulse Transmitter/Pulse Divider	7
2.3.1	Galvanically separated output module [Y=2]	7
2.3.2	Galvanically separated output module [Y=3]	8
2.4	Connection of power supply	9
2.4.1	Battery supply	9
2.4.2	Mains supply modules	9
2.4.3	Mains supply cable	10
2.4.4	Cable connections	11
2.4.5	Change of supply unit	11
2.5	Example of connection of Pulse Transmitter	11
2.5.1	Calculator with two flow sensors	12
2.6	Pulse Divider configuration CCC-DD-E-MMM	14
3	Operational check	15
4	Sealing	15
5	Accessories for Pulse Transmitter and Pulse Divider	16

1 Installation



Please read this guide carefully before installing the meter.

In case of incorrect mounting, Kamstrup's guarantee obligations no longer apply.

By connecting to 230 V supply, there is a risk of electric shock.

Mechanical environment

M1 (fixed installation with minimum vibration).

Electromagnetic environment

E1 and E2 (housing/light industry and industry). The meter's signal cables must be drawn with a distance of minimum 25 cm from other installations.

Climatic environment

Installation only in environments with non-condensing humidity as well as in closed locations (indoors).

The ambient temperature must be within 5..55 °C.

Maintenance and repair

It is permitted to replace the supply and the supply type in Pulse Transmitter/Pulse Divider. In case of battery supply, a lithium battery with connector from Kamstrup A/S must be used. Lithium batteries must be correctly handled and disposed of [see Kamstrup document 5510-408, "Lithium batteries - Handling and disposal"].

It is also permitted to replace the output module.

Other repairs require subsequent reverification in an accredited laboratory.

Note: At a medium temperature above 90 °C or a medium temperature below the ambient temperature, Pulse Transmitter/Pulse Divider may not be mounted on the flow sensor. Instead wall-mounting is recommended.

1.1 Orientation of Pulse Transmitter/Pulse Divider

When mounting Pulse Transmitter and Pulse Divider, the cable connections must always be oriented horizontally or downwards to avoid the risk of water and condensation being led into the box via the cables.

This is especially important in moist environments or at a medium temperature below the ambient temperature.

Furthermore, the wires/cables must in general hang freely downwards after the cable connections to form a drip nose for drainage of water and condensation.

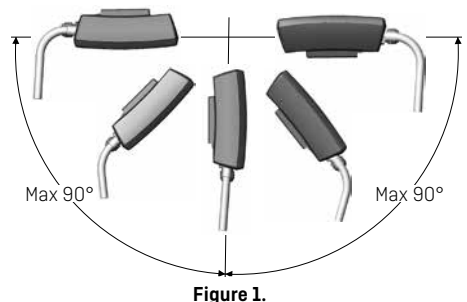

Figure 1.

1.2 Installation examples

Note: At a medium temperature above 90 °C or a medium temperature below the ambient temperature, Pulse Transmitter/Pulse Divider may not be mounted on the flow sensor. Instead wall-mounting is recommended.

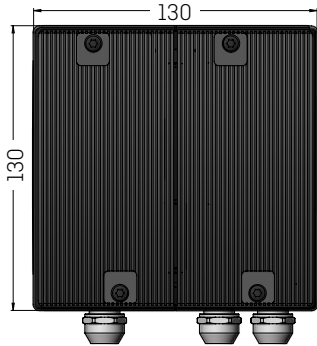

Figure 2. Pulse Transmitter/Pulse Divider seen from the front.



Figure 3. Pulse Transmitter/Pulse Divider seen from the side.

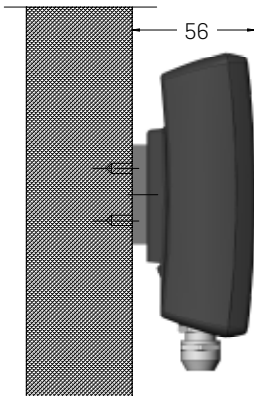

Figure 4. Wall-mounted Pulse Transmitter/Pulse Divider.

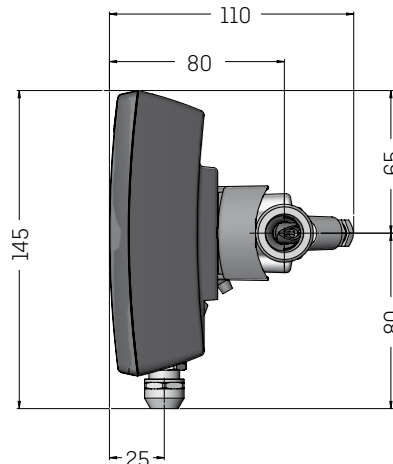

Figure 5. Pulse Transmitter/Pulse Divider mounted on ULTRAFLOW® 54 (Type 65-5-XXHX-XXX) G¾B.

2 Electrical connection

2.1 Signal cable length

The maximum permissible cable length between Pulse Transmitter/Pulse Divider and MULTICAL® depends on the used output module in Pulse Transmitter/Pulse Divider and the used connection to the MULTICAL® calculator.

Pulse Transmitter/ Pulse Divider output module	MULTICAL® 602/603/801/803	
	2-wire connection	3-wire connection
Y=2	< 100 m *	< 10 m
Y=3	N/A	< 10 m

Table 1. Maximum cable length between Pulse Transmitter/Pulse Divider and MULTICAL®.

If long signal cables are used, installation requires careful consideration. Due to EMC, there must be a distance of min. 25 cm between signal cables and all other cables.

* MULTICAL® 602/603 must be equipped with sensor connection type D and type G, respectively, and external 24 VDC supply. MULTICAL® 803 requires connection PCB for 24 V pulses.

2.2 Connection for ULTRAFLOW® and MULTICAL®

If ULTRAFLOW® and MULTICAL® are connected via Pulse Transmitter/Pulse Divider, ULTRAFLOW® is galvanically separated from MULTICAL®.

Note: Flow info is not possible when using Pulse Transmitter/Pulse Divider.

If ULTRAFLOW® is connected to other equipment than MULTICAL®, ULTRAFLOW® must be connected via Pulse Transmitter or Pulse Divider.

ULTRAFLOW®	⇒	Pulse Transmitter/ Pulse Divider
Blue [ground]	⇒	11
Red [supply]	⇒	9
Yellow [signal]	⇒	10

Table 2. Connection of ULTRAFLOW® to Pulse Transmitter/Pulse Divider.

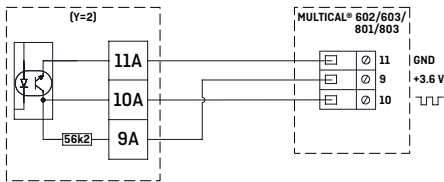

Figure 6. Three-wire connection of Pulse Transmitter/Pulse Divider with output module (Y=2) to MULTICAL® 602/603/801/803.

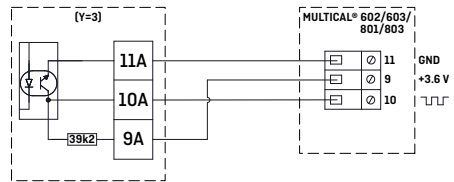

Figure 7. Three-wire connection of Pulse Transmitter/Pulse Divider with output module (Y=3) to MULTICAL® 602/603/801/803.

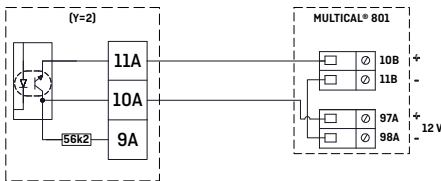

Figure 8. Two-wire connection of Pulse Transmitter/Pulse Divider with output module (Y=2) to MULTICAL® 801.

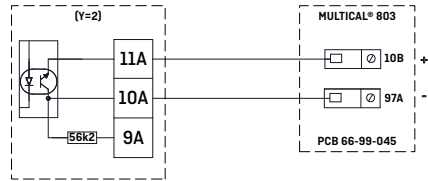

Figure 9. Two-wire connection of Pulse Transmitter/Pulse Divider with output module (Y=2) to MULTICAL® 803 with connection PCB for 24 V pulses.

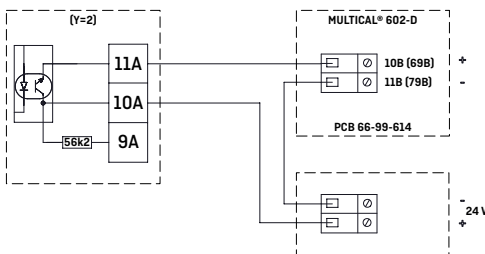

Figure 10. Two-wire connection of Pulse Transmitter/Pulse Divider with output module (Y=2) to MULTICAL® 602-D and external 24 VDC supply.

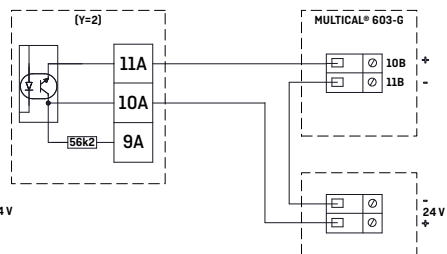

Figure 11. Two-wire connection of Pulse Transmitter/Pulse Divider with output module (Y=2) to MULTICAL® 603-G and external 24 VDC supply.

2.3 Pulse output in Pulse Transmitter/Pulse Divider

2.3.1 Galvanically separated output module (Y=2)

Pulse Transmitter/Pulse Divider is supplied from the integrated supply module.

The cable length to Pulse Transmitter/Pulse Divider depends on the calculator.

To calculator:

Type: Open collector.

Connection: Can be connected as two-wire or three-wire via the built-in 56.2 k Ω pull-up.

Module Y=2	OC and OD	(OB) Kam
Max input voltage	6 V	30 V
Max input current	0.1 mA	12 mA
ON state	$U \leq 0,3 \text{ V @ } 0,1 \text{ mA}$	$U_{CE} \leq 2,5 \text{ V @ } 12 \text{ mA}$
OFF state	$R \geq 6 \text{ M}\Omega$	$R \geq 6 \text{ M}\Omega$

Table 3.

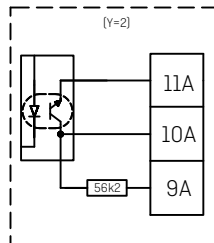

Figure 12. Block diagram for galvanically separated output module (Y=2).

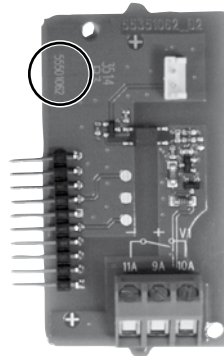

Figure 13. Galvanically separated output module (Y=2).
Note the PCB number 5550-1062 in the encircled area.

2.3.2 Galvanically separated output module (Y=3)

Pulse Transmitter/Pulse Divider is supplied from the integrated supply module/battery.

The cable length to Pulse Transmitter/Pulse Divider depends on the calculator.

To calculator:

Type: Open collector.

Connection: As three-wire via the built-in 39.2 kΩ pull-up.

Module Y=3	OC and OD
Max input voltage	6 V
Max input current	0.1 mA
ON state	$U \leq 0.3 \text{ V @ } 0.1 \text{ mA}$
OFF state	$R \geq 6 \text{ M}\Omega$

Table 4.

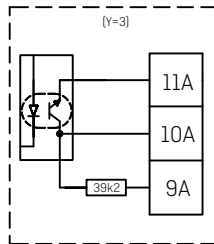

Figure 14. Block diagram for galvanically separated output module (Y=3).

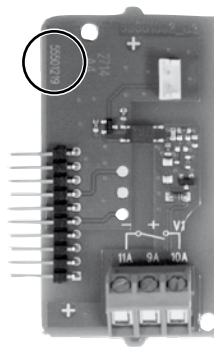

Figure 15. Galvanically separated output module (Y=3). Note the PCB number 5550-1219 in the encircled area.

2.4 Connection of power supply

If ULTRAFLOW® is connected via Pulse Transmitter or Pulse Divider, ULTRAFLOW® is supplied by the supply module/battery in Pulse Transmitter/Pulse Divider.

2.4.1 Battery supply

Pulse Transmitter/Pulse Divider is fitted with a D-cell lithium battery with connector. The battery is connected to the output module.

Optimal battery lifetime is obtained by keeping the battery temperature below 30 °C, e.g. by wall-mounting of Pulse Transmitter/Pulse Divider.

The voltage of a lithium battery is almost constant throughout the lifetime of the battery (approx. 3.65 V). Therefore, it is not possible to determine the remaining capacity of the battery by measuring the voltage.

The battery cannot and must not be charged and must not be short-circuited.

The battery can only be replaced by a corresponding lithium battery with connector from Kamstrup A/S. Used batteries must be handed in for approved destruction, e.g. to Kamstrup A/S (see Kamstrup document 5510-408, "Lithium Batteries - Handling and disposal").

2.4.2 Mains supply modules

The mains supply modules are protection class II devices and are connected to the output module via a short two-wire cable with mounted connector. The modules are powered via a two-wire mains supply cable (without earth connection) through the cable connector of Pulse Transmitter/Pulse Divider. Use mains supply cable with an outer diameter of maximum 10 mm, and ensure correct dismantling as well as correct tightening of cable connection (see 2.4.4 Cable connections, page 11).

Max permitted fuse: 6 A.

230 VAC

This PCB module is galvanically separated from the mains supply and is suitable for direct 230 VAC mains installation. The module includes a double-chamber safety transformer, which fulfils double-isolation requirements when the cover is mounted on the electronics box. Power consumption is less than 1 VA/1 W. National regulations for electric installations must be observed.

The 230 VAC module can be connected/disconnected by the district heating plant's personnel, whereas the fixed 230 VAC installation in the meter panel must be carried out by an authorized electrician.

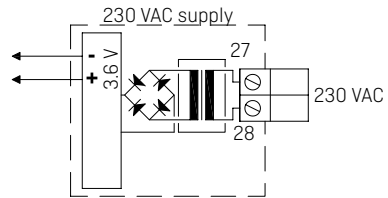

Figure 16.

24 VAC

This PCB module is galvanically separated from the 24 VAC mains supply and is suitable for both industrial installations with joint 24 VAC supply and individual installations supplied by a separate 230/24 VAC safety transformer in the meter panel. The module includes a double-chamber safety transformer which fulfils double-isolation requirements when the cover is mounted on Pulse Transmitter/Pulse Divider. Power consumption is less than 1 VA/1 W.

National regulations for electric installations must be observed.

The 24 VAC module can be connected/disconnected by the district heating plant's personnel, whereas the fixed 230/24 VAC installation in the meter panel must be carried out by an authorized electrician.

Note: This module cannot be supplied by 24 VDC (direct current).

230/24 VAC safety transformer

The 24 VAC module is specially suited for installation together with a 230/24 VAC safety transformer, e.g. type 66-99-403, which can be installed in the meter panel before the safety relay. When the transformer is used, the total power consumption of the meter including the 230/24 VAC transformer will not exceed 1.7 W.

2.4.3 Mains supply cable

Pulse Transmitter/Pulse Divider is available with mains supply cable H05 VV-F for either 24 VAC or 230 VAC (length: 1.5 m).

"H05 VV-F" is the designation of a strong PVC mantle, which withstands max 70 °C. Therefore, the mains cable must be installed with sufficient distance to hot pipes, etc.

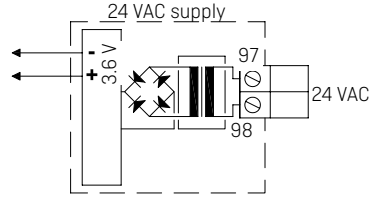

Figure 17.



Figure 18.

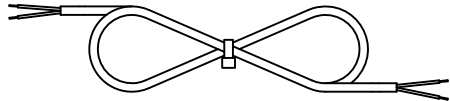

Figure 19. Mains supply cable (2x0.75 mm²), max 6 A fuse

2.4.4 Cable connections

Cable dimension in connections for signal cable: 2...6 mm

Cable dimension in connections for mains supply cable: 4.5...10 mm

Tightening torque: 4 Nm

Note: If battery supplied, the unused cable connection must be sealed off as shown in Figure 20.

2.4.5 Change of supply unit

The supply unit of Pulse Transmitter/Pulse Divider can be changed from mains supply to battery or visa versa as the needs of the utility change. Thus, it can be an advantage to change mains-supplied Pulse Transmitter/Pulse Divider to battery supply in buildings under construction where the mains supply can be unstable or periodically missing.

Note that the supply type for Pulse Transmitter/Pulse Divider is indicated on the label. If the original supply type is changed, it will no longer be in accordance with the label.

2.5 Example of connection of Pulse Transmitter

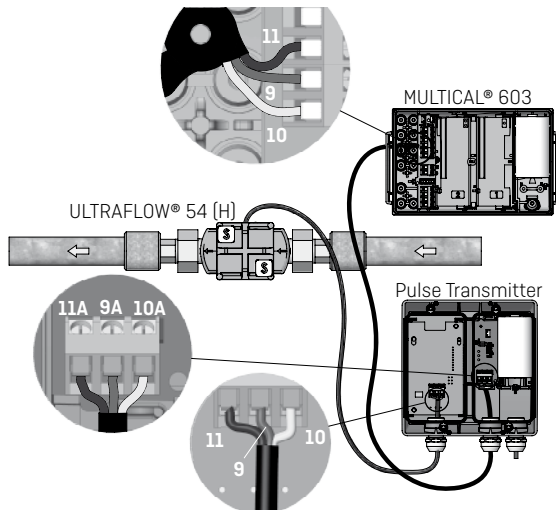

Figure 20. ULTRAFLW® 54 connected to Pulse Transmitter with battery supply. MULTICAL® 603 is connected via a 3-wire cable to the output module (Y=3) of Pulse Transmitter.

Note: The right cable connection of Pulse Transmitter is sealed off in case of battery supply.

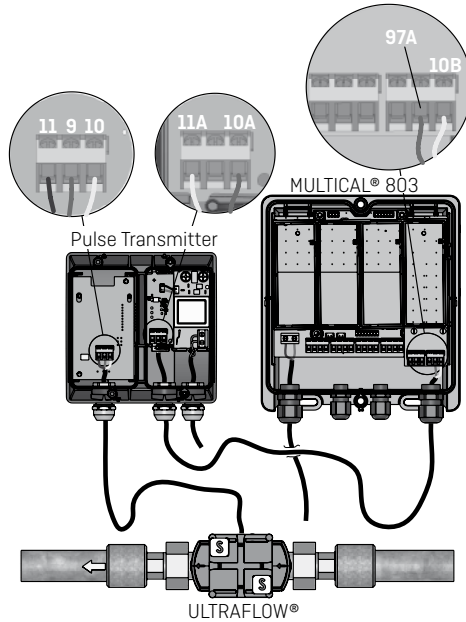

Figure 21. ULTRAFLow® 54 connected to Pulse Transmitter with 230 VAC supply. MULTICAL® 803 is connected via a 2-wire cable to the output module [Y=2] of Pulse Transmitter.

2.5.1 Calculator with two flow sensors

MULTICAL® 602/603/801/803 can be used in various applications with two flow sensors, e.g. leak surveillance or open systems. When two ULTRAFLow® are direct connected to one MULTICAL®, a close electric coupling between the two pipes ought to be carried out as a main rule. If the two pipes, however, are installed in a heat exchanger, close to the flow sensors, the heat exchanger will provide the necessary electric coupling.

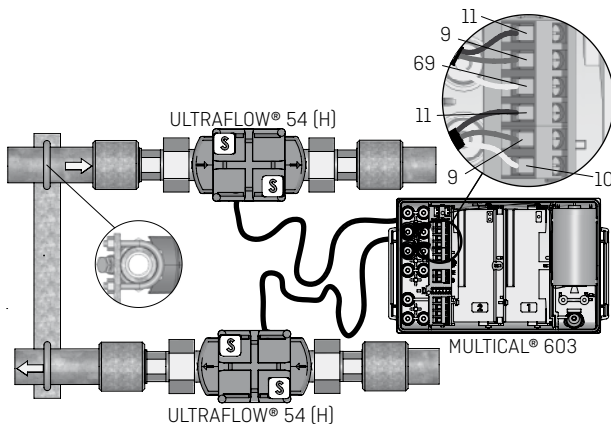

Figure 22. Inlet and outlet pipes are closely electrically coupled. No welded joints occur.

In installations where the electric coupling is not possible or welding in the pipe system can occur, the cable from one ULTRAFLOW® must go through Pulse Transmitter with galvanic separation before the cable enters MULTICAL®.

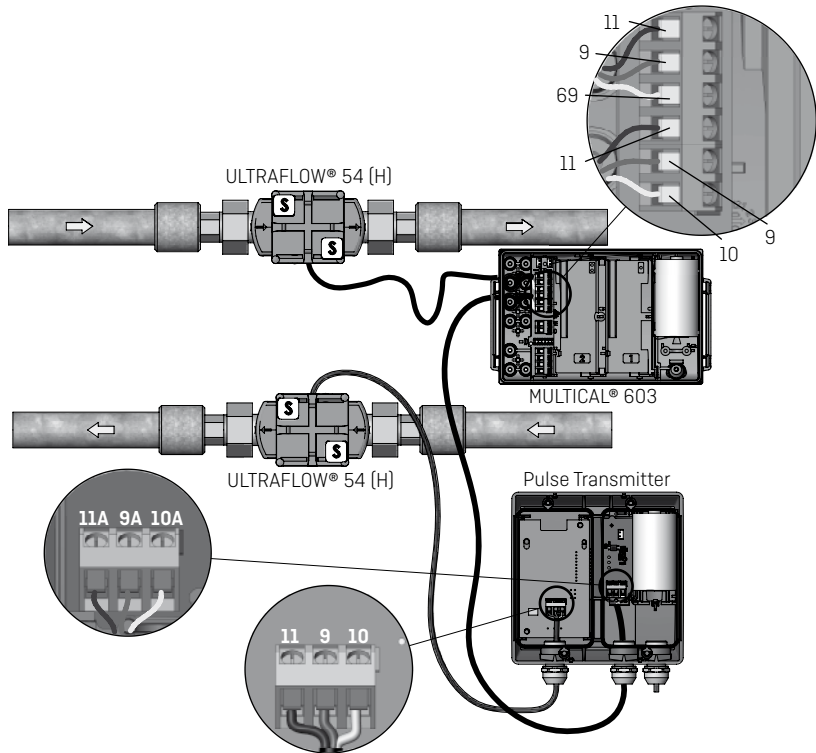

Figure 23. Inlet and outlet pipes are not necessarily closely coupled. Electric welding* can occur.

* Electric welding must always be carried out with the earth pole closest to the welding point. Damage to meters due to welding is **not** comprised by Kamstrup's factory guarantee.

2.6 Pulse Divider configuration CCC-DD-E-MMM

When ordering, Pulse Divider must be configured to ULTRAFLOW® meter factor (CCC) as well as to the required Pulse Divider meter factor (DD) and pulse duration (E) according to Table 5 and Table 6.

Pulse Divider can be reconfigured via METERTOOL HCW (see the technical description 5512-2097_GB).

MMM indicates choice of customer label.

ULTRAFLOW® 54 & 34			Pulse Divider, pulse duration 100 ms (E6)											
q _p	Meter factor	CCC	Meter factor DD33	Divider	Meter factor DD63	Divider	Meter factor DD34	Divider	Meter factor DD64	Divider	Meter factor DD35	Divider	Meter factor DD65	Divider
[m ³ /h]	[p/l]		[l/p]		[l/p]		[l/p]		[l/p]		[l/p]		[l/p]	
0.6	300	116	1	300	2.5	750								
1.5	100	119	1	100	2.5	250	10	1000						
2.5	60	198	1	60	2.5	150	10	600						
3	50	151			2.5	125	10	500	25	1250				
3.5	50	151			2.5	125	10	500	25	1250				
6	25	137			2.5	62.5	10	250	25	625				
10	15	178					10	150	25	375				
15	10	120					10	100	25	250	100	1000		
25	6	179					10	60	25	150	100	600		
40	5	158							25	125	100	500	250	1250
60	2.5	170							25	62.5	100	250	250	625
100	1.5	180									100	150	250	375

Table 5. Configuration variants for meter factor (DD) at a pulse duration of 100 ms.

ULTRAFLOW® 54 & 34			Pulse Divider											
q _p	Meter factor	CCC	Pulse duration 20 ms (E4)				Pulse duration 50 ms (E5)							
			Meter factor DD33	Divider	Meter factor DD34	Divider	Meter factor DD33	Divider	Meter factor DD34	Divider				
[m ³ /h]	[p/l]		[l/p]		[l/p]		[l/p]		[l/p]		[l/p]		[l/p]	
0,6	300	116	1	300				1	300					
1,5	100	119	1	100				1	100					
2,5	60	198	1	60				1	60					
3	50	151	1	50				1	50					
3,5	50	151	1	50				1	50					
6	25	137	1	25				1	25					
10	15	178	1	15				1	15					
15	10	120	1	10						10	100			
25	6	179	1	6						10	60			
40	5	158					10	50				10	50	
60	2,5	170					10	25				10	25	
100	1,5	180					10	15				10	15	

Table 6. Configuration variants for meter factor (DD) at pulse durations of 20 ms and 50 ms.

3 Operational check

Carry out an operational check when the complete meter (flow sensor, temperature sensors and calculator) has been installed and connected. Open thermostats and valves so that water is flowing in the system and check that there are credible values for temperatures and water flow in the calculator display.

4 Sealing

On delivery of Pulse Divider with a MID-verified flow sensor, Pulse Divider is sealed with laboratory marks as shown in Figure 24. Pulse Transmitter is not sealed.

If the seal of a verified sensor is broken, the sensor must be verified before being installed in a location demanding verification.

Separately ordered Pulse Transmitter/Pulse Divider will be without verification and are therefore delivered without sealing.

In the figure, the sealing is divided into the following groups:

S Laboratory marks. Sealing of screws.

T Type label (as void label or with sealing S).

I Installation seal (wire and seal or seal mark).

Note: Sealing requirements may vary as a consequence of national regulations.

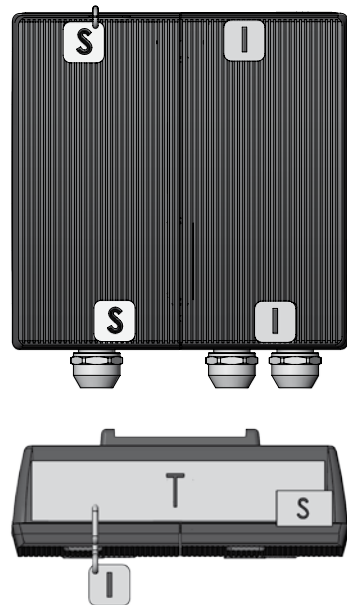

Figure 24. MID sealing of Pulse Divider.

5 Accessories for Pulse Transmitter and Pulse Divider

Note that not all article numbers can be directly ordered, some must be ordered via Kamstrup's service department.

Article number	Description	Note (When ordering Pulse Transmitter and Pulse Divider)
65-000-000-2000	D-cell lithium battery with two-pole connector	
3026-477 *	Fitting for D-cell battery	Enclosed if battery supply or "No supply" is selected
1650-157 *	Plug for cable connection	Enclosed if battery supply or "No supply" is selected
65-000-000-7000 **	230 VAC supply module	
65-000-000-8000 **	24 VAC supply module	
5000-290	Cable between supply module and output module	Enclosed if supply module is selected
5000-286	24/230 VAC mains supply cable	Optional
66-99-012	Output module (Y=2), galvanically separated (5550-1062)	
66-99-013	Output module (Y=3), galvanically separated, low power (5550-1219)	
5000-333	2.5 m silicone cable (3-wire)	Optional
5000-259	5 m silicone cable (3-wire)	Optional
5000-270	10 m silicone cable (3-wire)	Optional
3026-207.A	Wall bracket including mounting kit	Optional

Table 7. Accessories for Pulse Transmitter and Pulse Divider.

* Necessary when changing from mains supply to battery supply.

** Including 5000-290.