

Data sheet

READY Ethernet inputs (In-A, In-B)

MULTICAL® 603

MULTICAL® 803

- Connects and sends data automatically to READY
- Ethernet 10/100BASE-T
- Plug-and-play solution
- Data sent every hour
- Up to 14 days of data backup



Contents

Introduction	3
Cable connections	4
Communication from module	5
Technical data	6
Ordering	6
Configuration	6
Displayed information	7

Introduction

A high performance ethernet module developed for the MULTICAL® energy meter. The module supports direct communication to Kamstrup READy manager. All data needed for billing and heat intelligence are sent at hourly basis.

Application

The READy Ethernet module is designed with focus on simple installation and plug-and-play commissioning. The module is a wired solution having the same functionality as the HC-003-80 2G/4G network module. Thus this module provides a wired alternative to those people who are uncomfortable with radio-based equipment.

Data transmitted from the meter to the data management (MDM) system is protected via end-to-end encryption. The data registers are encrypted using AES128 encryption, located in the energy meter and the transport layer is protected using a unique AES256 encryption key, located in the communication module itself.

If the connection to the network and the MDM system is lost, the module continues to log hourly values and transfers the missing hourly values as soon as the connection is re-established. It is possible to transfer hourly values for the latest 14 days.

Installation

The module is easily mounted on a free module space in the meter. No configuration is required.

To verify that communication to READy Manager is established, use the CALL function. Press and hold the meters front buttons, until "CALL" is displayed. In this instant, the module sends a connection request to the READy manager, and once connection is established, "OK" is shown in the display, typically within 1..5 seconds.

Alternately, you can check that the meter data has been read on "<https://check.kamstrup.com/#/>" by entering the meters serial number.

⚡ The module is power-supplied from the meter's internal 230 VAC or 24 VAC High-Power supply.

⚠ The HC-003-83 READy Ethernet module must not be combined with a HC-003-80 2G/4G network module.

Cable connections

Terminals

Max cable size: 1.5 mm²



Pulse inputs

- Terminal 65: Pulse In-A (+)
- Terminal 66: Pulse In-A (-)
- Terminal 67: Pulse In-B (+)
- Terminal 68: Pulse In-B (-)

Ethernet

- Terminal 117: Green
- Terminal 116: Green/White
- Terminal 115: Orange
- Terminal 114: Orange/White

Pulse inputs

The module is equipped with two pulse inputs, In-A and In-B, to collect and accumulate pulses, e.g. from water and electricity meters.

The pulse inputs are physically placed on the module. However, the accumulation and logging of values are performed by the MULTICAL® calculator.

When installing a module with pulse inputs in slot 2 of MULTICAL® 603 and MULTICAL® 803, the pulse inputs will be registered in the meter as In-A2 and In-B2.

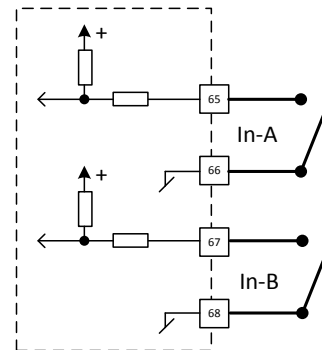

Ethernet

⚠ Use a standard patch cable cut in half, then you can feed the cable end without RJ45 plug through the holes in the meter and connect the wires to the module. The RJ45 connector then goes into an ethernet switch.

The color coding on the module are according TIA/EIA-568, T568B termination.

Colors on various brands of cable may deviate.

Communication from module

Once the module connects to the READy manager, data are sent from the module every hour. If connection is lost, data will be logged for up to 14 days. Once the communication is re-established, the logged data are passed on to the READy Manager.

Protocol

Data are sent via the UDP protocol and are end to end encrypted for high secured transport.

Network options

The module requires that the network has a DHCP server and internet access.

Datagram

The datagram contains the most common registers used for billing and heat intelligence.

Datagram		
Heat energy E1	Volume V1	Tariff TA2
Heat energy E2	Volume V2	Tariff TA3
Cooling energy E3	Flow V1 actual	Tariff TA4
Cooling energy E3_HC	Flow V2 actual	Pulse input A1
Inlet energy E4	Power actual	Pulse input B1
Energy E8	t1 actual (2 decimals)	Info bits
Energy E9	t2 actual (2 decimals)	Operation hours
Energy E10	t3 actual (2 decimals)	Error hour counter
Energy E11	Mass M1	
COP	Mass M2	
Heat energy A1	P1 actual - part 1 *	
Heat energy A2	P2 actual - part 1 *	

* The P1 and P2 supports SI units of Pressure BAR, Relative Humidity % RH and Temperatures °C, all with 0,1,2 or 3 decimals.

Technical data

Physical

For installation in MULTICAL® 603 and MULTICAL® 803

Mechanical data

Dimensions (L x W x D) 90 x 35 x 14 mm
Weight < 45 g

MULTICAL® supply

High Power SMPS

Communication

Protocol UDP
Data rate 10/100 Mbit/s

Bus-specific

Type Ethernet IPV4
Galvanic isolation > 2 kV

Pulse inputs

Input type Contact input
Open voltage 3.6 V
Current ≤ 5 µA
Max cable length 10 m

Environment

Operational temperature 5 °C – 55 °C
Humidity 25 – 85 % RH non-condensing

Markings/approvals

CE, MID together with the type approval of MULTICAL® 603 and MULTICAL® 803

Ordering

Description

READy Ethernet, inputs (In-A, In-B)
USB configuration cable for H/C-modules
Infrared optical readout head w/USB A plug
METERTOOL HCW
READy

Order No.

HC-003-83
6699-035
6699-099
www.kamstrup.com
www.kamstrup.com

Configuration

Product type of module	XX	YY	ZZZ
READy Ethernet, inputs (In-A, In-B)	83	10	100
System			
READy		10	
Datagram			
Default datagram			100
Reserved			ZZZ

Displayed information







Module information can be read by selecting TECH loop on the MULTICAL® display.

Module in module slot 1: Select menu 2-101 in TECH loop.

Module in module slot 2: Select menu 2-201 in TECH loop.

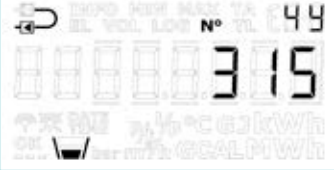
Module in module slot 3: Select menu 2-301 in TECH loop.

Module in module slot 4: Select menu 2-401 in TECH loop.

Menu	Menu index	Information	Display example
2-x01	31	Module type and configuration	
2-x01-1	32	Module firmware and revision	
2-x01-2	33	Module serial number	
2-x01-3	44	Number of bytes sent (kilo bytes)	
2-x01-4	45	Number of bytes received (kilo bytes)	
2-x01-5	47	Link information *	
2-x01-6	49	Module status **	

* Link information has 4 bits of information:

Bit number	Value when bit = 1	Meaning	Value when bit = 0	Meaning
3	8	100 Mbit	0	10 Mbit
2	4	Full Duplex	0	Half Duplex
1	2	Auto Negotiation complete	0	Auto Negotiation in progress
0	1	Link	0	No Link

A value of 15 means: 100 Mbit, Full Duplex, Auto Negotiation Completed and Link

** Module status has 3 bits of information:

Bit number	Value when bit = 1	Meaning	Value when bit = 0	Meaning
2	4	No Link	0	Link
1	2	Internal error	0	OK
0	1	No configuration	0	OK

If module status shows other values than 0 or 4, the module must be sent in for repair.